

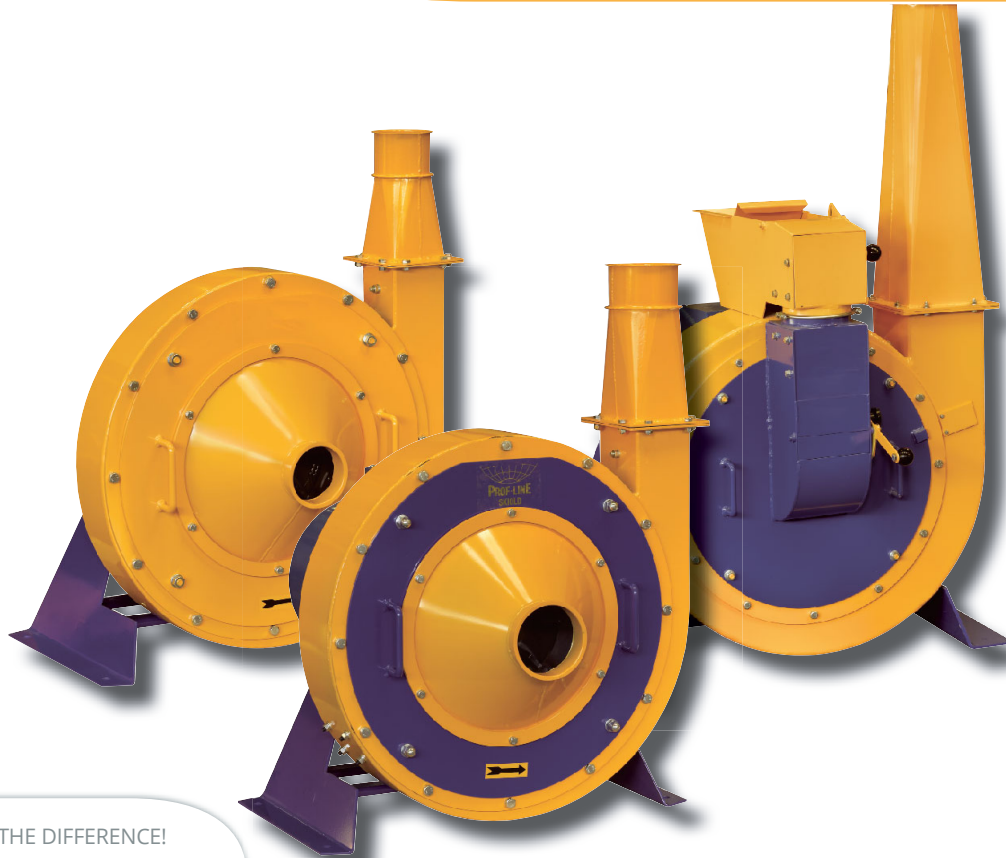

SKIOLD HAMMERMILLS



SKIOLD MAKES THE DIFFERENCE!



SKIOLD HAMMERMILLS DM-2 / DM-3 / BM-5

Hammermills with capacities up to 2500 kg/h

Conveying capacities up to 80 metres

Comprehensive range of accessories

Low current consumption

Flexible application

Few wearing parts



The Hammermill

The mills are ideally suited for grinding of animal feed, and are supplied complete with a built in fan. This fan enables the raw and ground material to be conveyed throughout the system, and has an additional advantage of cooling the meal in the process. The simple but robust construction of the mill enables it to be accommodated into most existing systems.

DM-2

The DM-2 is supplied with a 5.5 kW or 7.5 kW motor, giving a capacity of up to 500 kg per hour and a conveying capacity of up to 70 m. This mill is recommended for a daily consumption of up to 2 tonnes.

DM-3

The DM-3 is supplied with a 11, 15, or 18.5 kW motor, giving a capacity of up to 1300 kg per hour, with a maximum conveying capacity of 80 m. This mill is recommended for a daily consumption of up to 5 tonnes.

BM-5

The BM-5 is the biggest and most robust model in the range, and is equipped with a 37 kW motor. It has a capacity of up to 2.5 tonnes per hour, but the conveying capacity is limited to approximately 30 m.

Wearing Parts

All wearing parts in the mill are easily replaced by original SKIOLD parts. The wearing parts are made of quality material which ensures that servicing of the mill is kept to a minimum. Constant research into prolonging the durability of the parts is carried out as well as constant surveillance of new raw materials as they become available on the market.

Hammers

The hammers are made of hardened spring steel with a great wear resistance. All the hammers in one set are weighed so that the mill does not vibrate during operation. The hammers are reversible up to 4 times to increase durability.

Screens

The range of screens covers hole sizes from 1.0 mm to 12 mm, enabling most structure to be obtained.

Fans

The fan wings vary for the various mill types, with 2, 4 or 8 wings depending on what is required. Special versions with extra wear resistance are available for DM-2 and DM-3 models.

Protection Cover

The protection cover prevents the mill housing from wearing on the inside. Protection covers with extra wear resistance are available for the DM-2 and DM-3.



Accessories

A comprehensive range of accessories is available for the SKIOLD mills. This gives greater flexibility and adaptability into the SKIOLD range of mixers, proportioners and many other existing systems.

Cyclone and Filter

With air conveying a cyclone is necessary for separating the feed from the air. The cyclones are adapted to the various mill types in order to obtain the maximum separation. The air outlet of the cyclone is equipped with a filter for collecting fine dust, or the air discharge can be expelled into the open air and fitted with a rain cap.

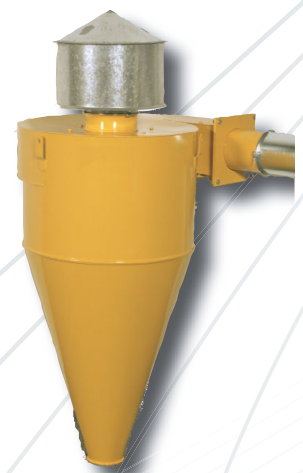

Feeding device

The material is sucked into the mill through a feeding device which for safety reasons is fitted with a magnet for catching possible iron parts in the grain. The feeding devices are available in lengths of 0.5, 1.0 and 2.0 m. They can be mounted directly on the silo outlets by means of a connection.

Stone Trap

In order to protect the mill against damage, a stone trap is always mounted in the suction pipe. The stone trap separates all that is heavier than the grain, and a special device takes care that the stone trap is emptied automatically.

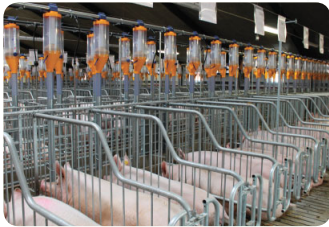

Milling

The structure of the ground material depends primarily on the screen size, but also on the raw material. For example wheat is easier to grind than barley, therefore when using the same screen size for both wheat and barley, the result will be a much finer structure on wheat.

The water content in the grain also influences on the structure, the more saturated the material the coarser the structure. Oats are especially difficult to cut up, and will often, after grinding contain large quantities of whole shell parts which makes it difficult for the feed to flow through the silos.

Capacity

The mill capacity depends on the raw material, water content, screen size and the conveying length which consequently makes it difficult to precisely indicate. The indicated capacities are based on barley with 3 mm screen and a water content of 15%. An increased water content and a smaller screen size reduces the capacity. In maize the capacity is approximately 30% higher than in barley. It is a principal rule that a change of screen by 1 mm changes the capacity by approximately 25%.

Booster fan

In plants where the mills own fan is not sufficient, a booster fan can be built into the system which increases the conveying capacity by up to 150 m. The fan is built into the mill blowing line and does not increase the air quantity, but only the pressure in the system. The fan can be placed anywhere in the fan pipe of the mill, but there must be a minimum of 2 m straight pipe on the inlet and outlet of the fan, before a bend is placed. For the operation of the booster fan there is a special electrical panel which is connected to the controller of the mill.

Conveying

The built in fan of the mill enables raw and ground material to be conveyed throughout the system. The conveying capacity depends on the motor size and the number of fan wings in the mill. At installation, it must be considered that the mill capacity to suck is better than its capacity to blow. The indicated conveying lengths are horizontal lengths. At calculation, the vertical ascent should be counted twice and each bend counted as 3 m. The air quantity in the system is adjusted with the throttle in the feeding device and at the cyclone.

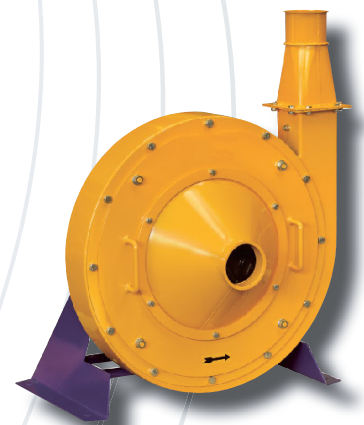

Capacities - Mills

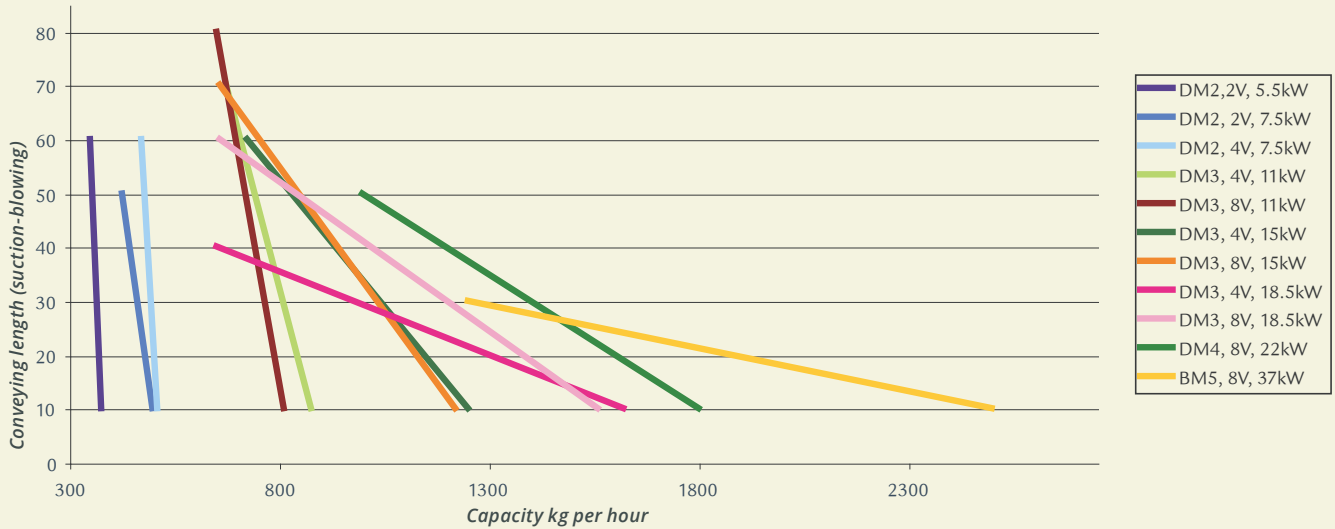

5.5/2 to be read: 5.5 kW with 2 fan wings etc.

At suction at the back of the mill 5 to 10 metres conveying capacity is lost.

Capacity / conveying

The stated capacities and conveying lengths are only advisory and will be heavily depending on raw material, screen size, moisture of the grain and mutual relation between suction and blowing lengths. A more exact indication of the capacity can be informed by SKIOLD or the dealer by indicating suction and blowing lengths as well as raw material and its moisture.

DIMENSIONS, MM

| | A | B | C | D | E |
|-------|------|-----|------|-----|-------|
| DM-2* | 700 | 675 | 430 | 355 | 225 |
| DM-3 | 700 | 679 | 430 | 355 | 277,5 |
| BM-5 | 1000 | 810 | 1000 | 450 | 700 |

* also DME booster fan

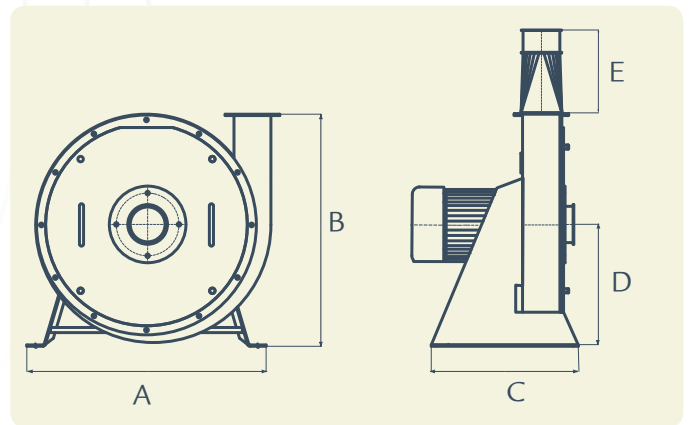

TECHNICAL DATA

| | DM-2/2 | DM-2/4 | DM-3/4 | DM-3/8 | BM-5/8 |
|--------------------------------------|--------|--------|--------|--------|---------|
| Suction pipe - front, mm diameter | 80 | 80 | 100 | 100 | 120/150 |
| Suction pipe - back, mm diameter | 80 | 80 | 80 | 80 | 100 |
| Blowing pipe, mm diameter | 100 | 100 | 120 | 120 | 150 |
| Air speed, m/sec. | 20 | 20 | 20 | 20 | 20 |
| Air quantity m ³ per hour | 565 | 565 | 815 | 815 | - |
| Max. air pressure mm WS | 160 | 275 | 450 | 540 | - |
| Necessary filter m ³ | 9 | 9 | 15 | 15 | 30 |
| Necessary filter, 200 mm diameter | 12 | 12 | 24 | 24 | 50 |

Grinding Fineness

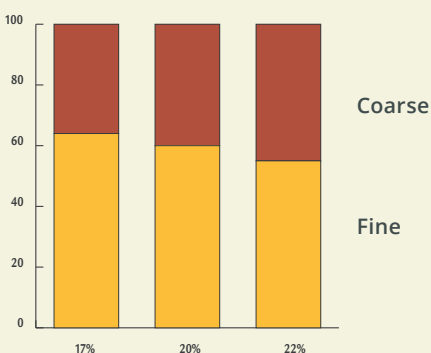

Water content

Grinding Capacity

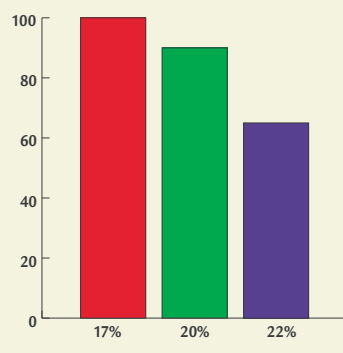

Water content

Conveying Ability, Booster Fan

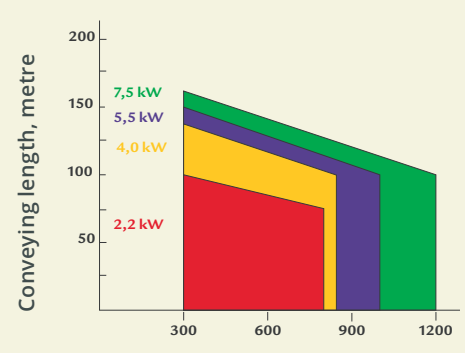

Capacity kg per hour